

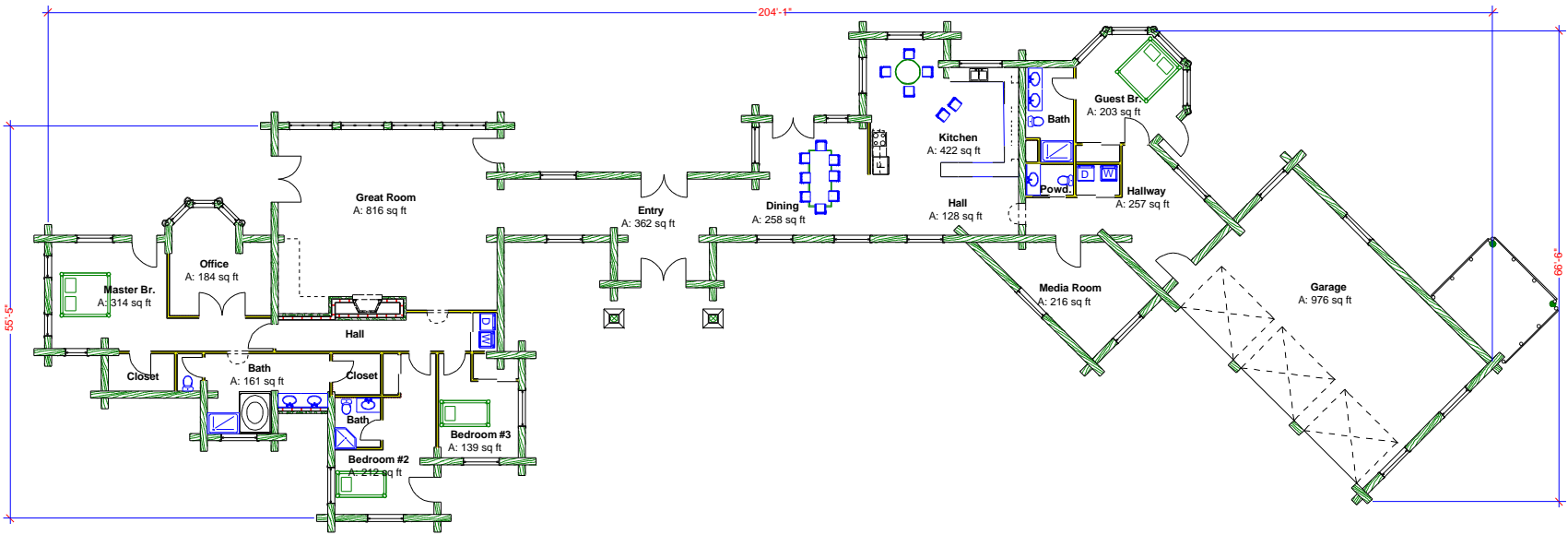

Copyright © 2003  
All rights reserved.  
FAX# 360-404-7083  
PH# 360-966-8860  
rick@logdesign.com



# The Ocelot

Main Floor  
4,610 sq ft

Not for  
Construction

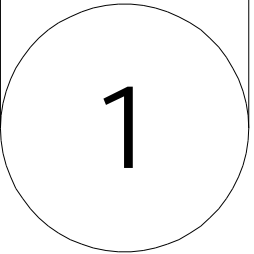

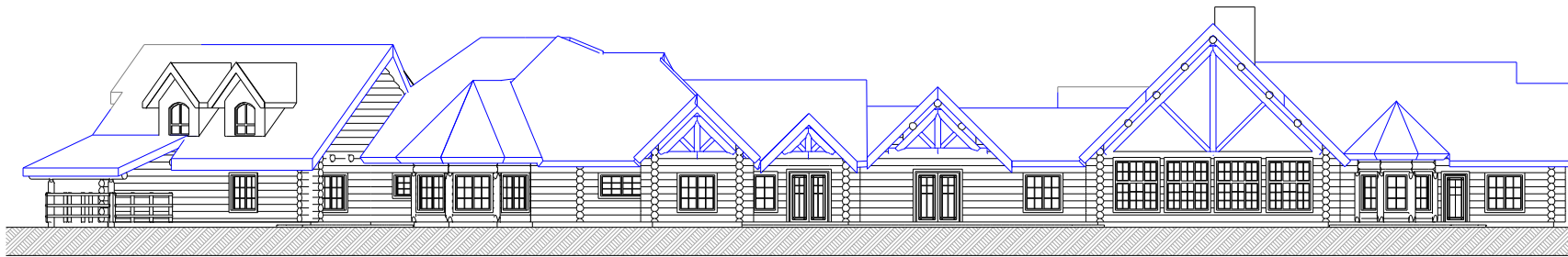

1 NORTH ELEVATION  
1/8" = 1'-0"

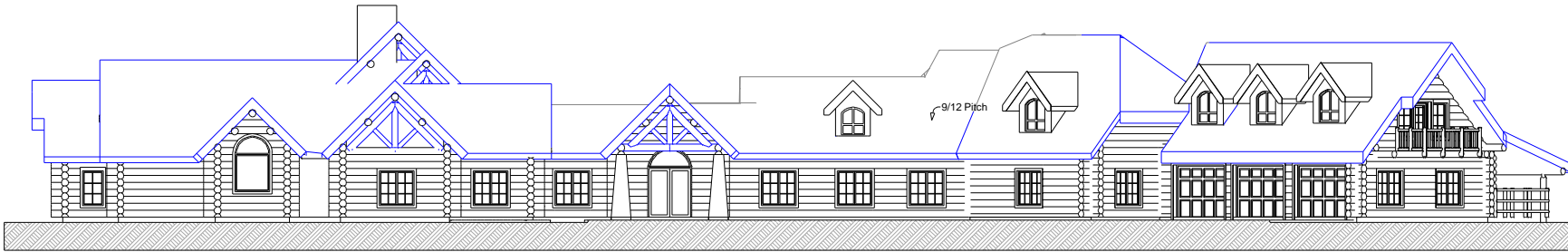

1 SOUTH ELEVATION  
1/8" = 1'-0"

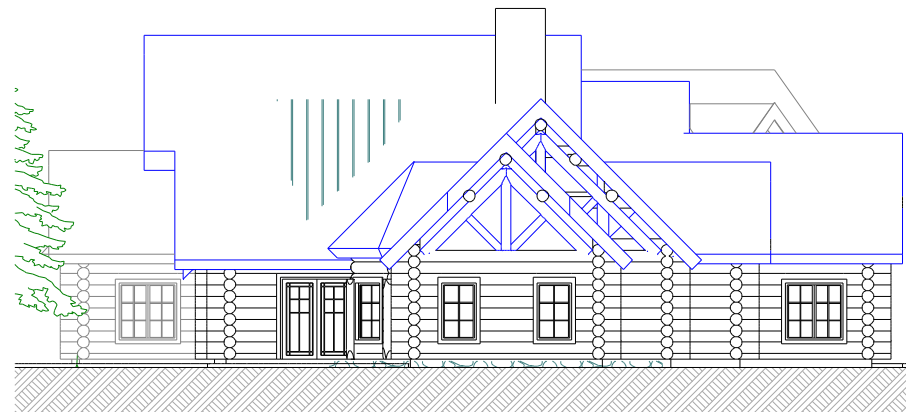

2 WEST ELEVATION  
1/8" = 1'-0"

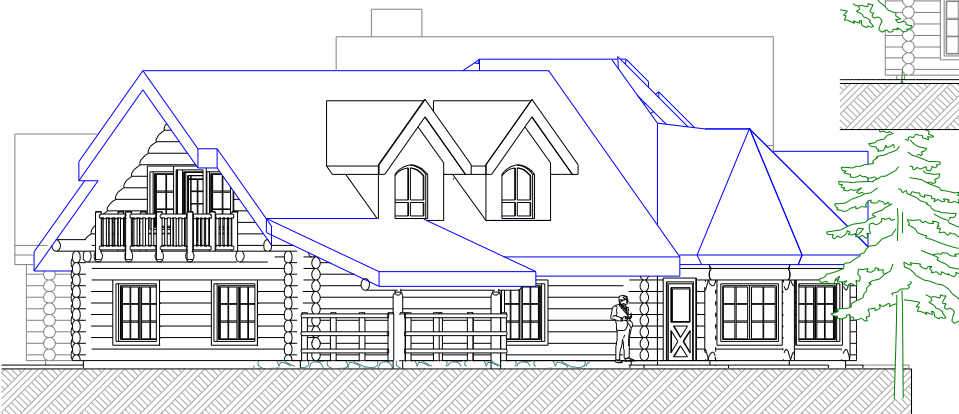

2 EAST ELEVATION  
1/8" = 1'-0"

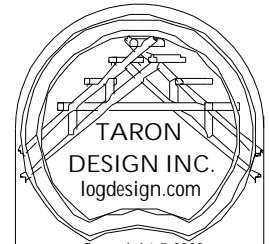

TARON  
DESIGN INC.  
logdesign.com

Copyright © 2003  
All rights reserved.

FAX# 360-404-7083

PH# 360-966-8860

rick@logdesign.com

The Ocelot  
Elevations  
4,610 sq ft

Not for  
Construction

2